

ASSEMBLY INSTRUCTIONS:

Product Code : GL305/4 & GL380/4

Product Name: GO Steel Lockers - 4 Door

TIME REQUIRED:

35 minutes

TOOLS REQUIRED:

Pop Rivet Gun

*Tools are not included.

SKILL REQUIRED:

Easy  Hard

The Assembly Skill Rating is a 5-point system that shows the degree of effort needed in assembling a specific product. With 1 being easy for the average person and 5 requiring an expert. For most products, two persons are recommended.

NOTE

- As this is a commercial product, some intermediate skills may be required.
 - No pre-drill holes or markings are provided on our table or desk tops.
 - Please check you have all hardware before assembling.
- If you are missing any hardware, please contact your Rapidline reseller. Please ensure you have the name of the item, required hardware part and quantity.
 - Please retain your receipt as proof of purchase to validate your warranty.
- Assemble on a clean, flat, smooth surface such as a rug or carpet to avoid parts from being scratched.
 - Remove all wrapping materials, including staples and packing straps before you start to assemble
 - Keep all hardware parts out of reach of children.

CAUTION

- Heavy product. Do not attempt to lift or move without help
- Do not tighten screws and bolts until completely assembled.
- Do not use this product unless all bolts and screws are firmly secured and tightened.

WARNING

- If parts are missing, broken, damaged or worn stop using the product until all repairs are made.
 - Failure to follow these warnings could result in serious injury.

GC 305 / 1,2 AND 4 DOOR LOCKERS ASSEMBLY INSTRUCTIONS

PART LIST

Part No	Component	Quantity
01	Back	01
02	LH SIDE with cam slots	01
03	RH SIDE with hinge slots	01
04	TOP	01
05	BOTTOM TRAY	01
06	Bottom Front	01
07	SHELF	1,1 and 3
08	DOOR	1,2 and 4
09	LOCKS	1,2 and 4
10	RIVETS 3.2X8	33,33 and 41
11	RIVETS 4X8MM FOR COAT HOOK	04
12	RIVETS 4X8 counter sunk for door	6,8 and 16
13	HANGING ROD/COAT HOOK	1,2

***The Qty of SHELVES AND RIVETS is given for GL305/1 , GL305/ 2 AND GL 305/4 RESPECTIVELY

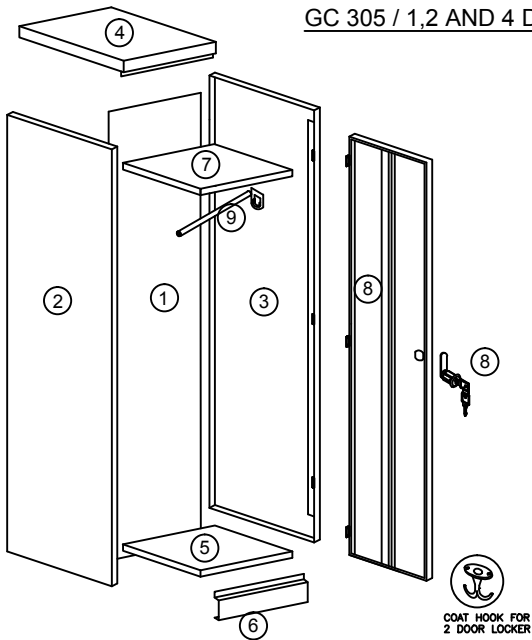

STEP-1

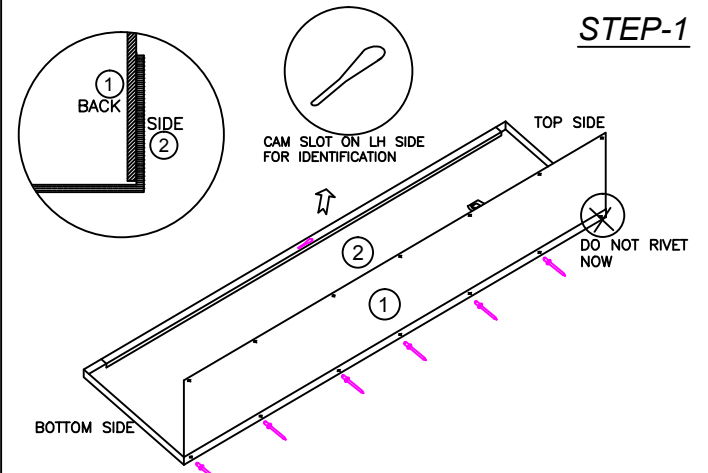

Place the LH Side Panel (With CAM SLOT on the Flat surface(Assly Table) and rivet the back panel with the panel as shown except the two top hole (which will be riveted along with the Top panel) rivet from outside to inside.

STEP-2

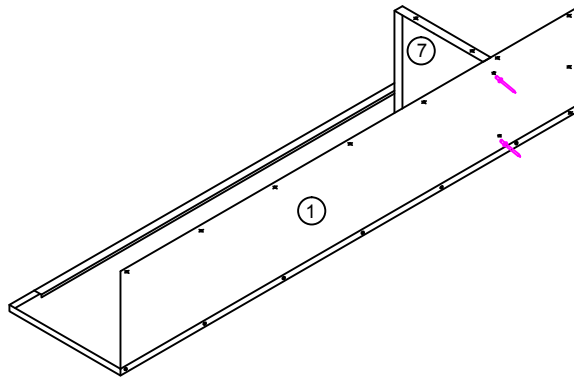

Rivet the shelf with the back panel as shown in the drawing (rivet from outside to inside)

STEP-3

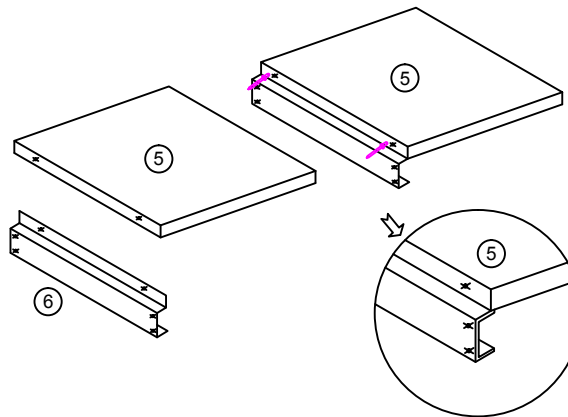

Insert the top flange of the bottom front into the bottom tray and rivet as shown in the drawing (seperate sub assembly)

STEP-4

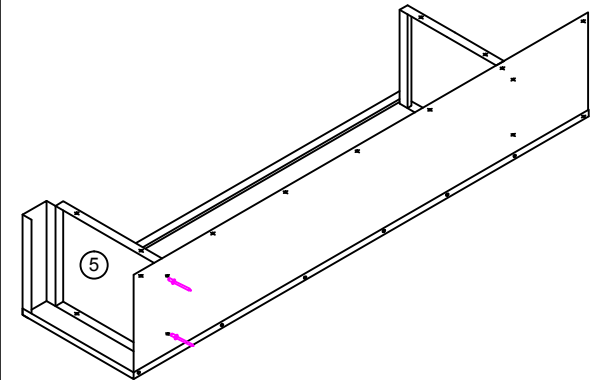

1. Rivet the SHELF(Shelves) with the back panel as shown.
2. Rivet the bottom tray and bottom front assembly with the back panels as shown.
3. Rivet the bottom front with the side.

STEP-5

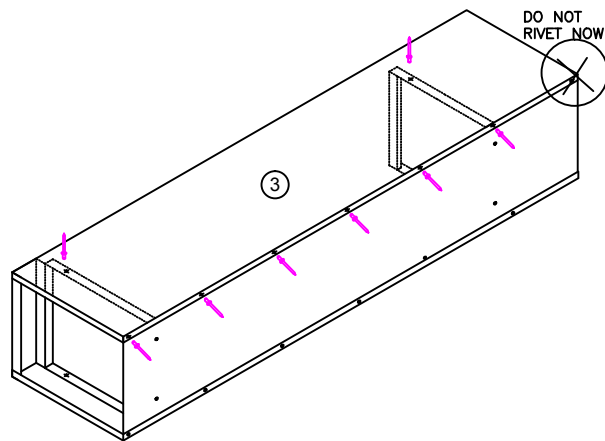

1. Place the RH side on Back, Shelf and Bottom Tray as shown.
2. Rivet the side with the back on all the holes except the top hole and also rivet the side with the shelves and bottom tray as shown.

STEP-6

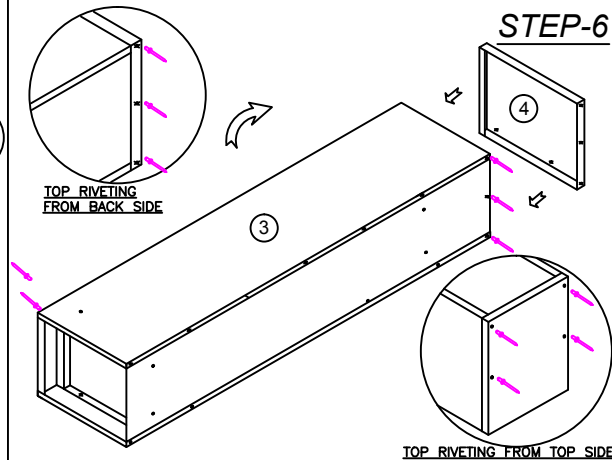

1. Fix the Top as shown and Rivet with the back and sides as shown.
2. Fix COAT HOOK in 2 door locker on top and shelf (applicable to 2 door locker only)
3. Flip the Locker on Its back as shown (Back touches ground) for rivetting the Shelf, Bottom tray with the LH Side.

STEP-7

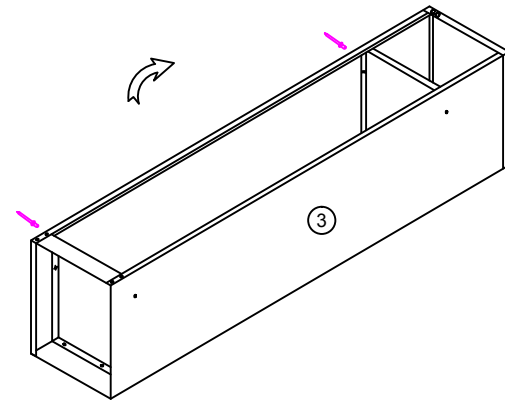

1. Rivet the LH side the Shelves and the Bottom Tray as shown.
2. Again Flip around the Locker in Its RH side as shown for DOOR FIXING.

Use 4x8mm Counter sunk Rivets for Door Fixing

STEP-8

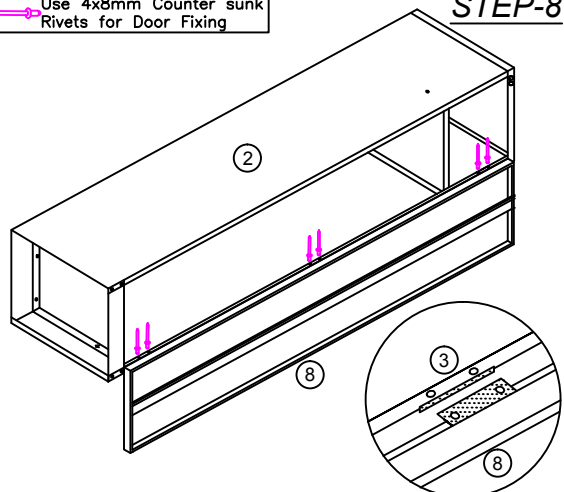

Hinge slots on RH Side

1. Position the door in the hinge slots of RH side as shown and rivet the door using counter sunk riverts and then lift erect the locker.

STEP-9

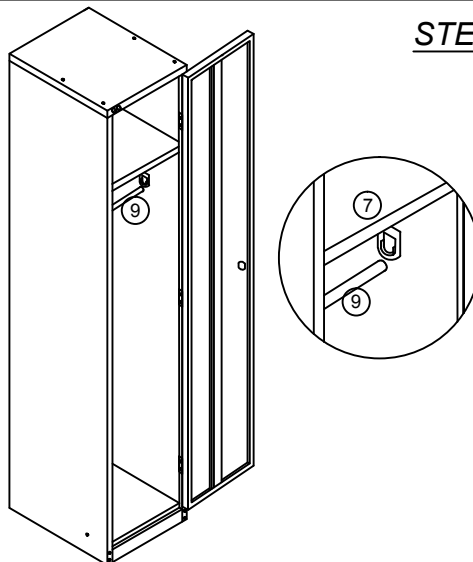

1. Fix the Coat hanger in the 1 door locker as shown.
2. Fix the Coat hanger in the 2 door locker in step no 6 (Applicable to 2 door locker only)

STEP-10

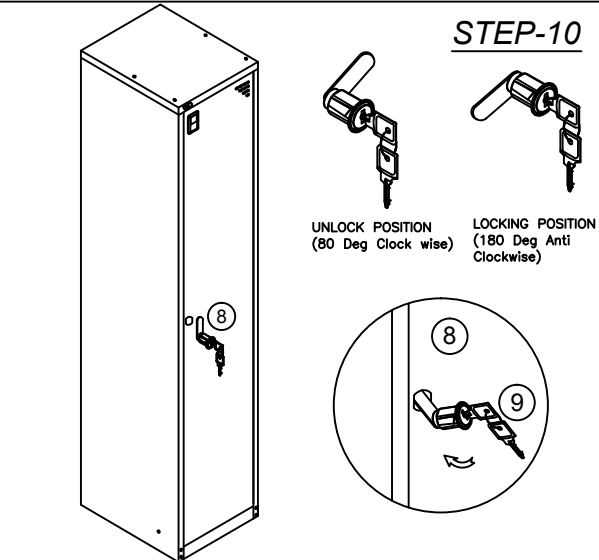

1. Check the lock for unlock and lock condition before fixing in hand.
2. Insert the lock in unlock condition and press completely as shown.